



L : 398
l : 272
H : 378



150 : 26 m²



0,24 m³



4 - 8 h



2/3



27





13 mm

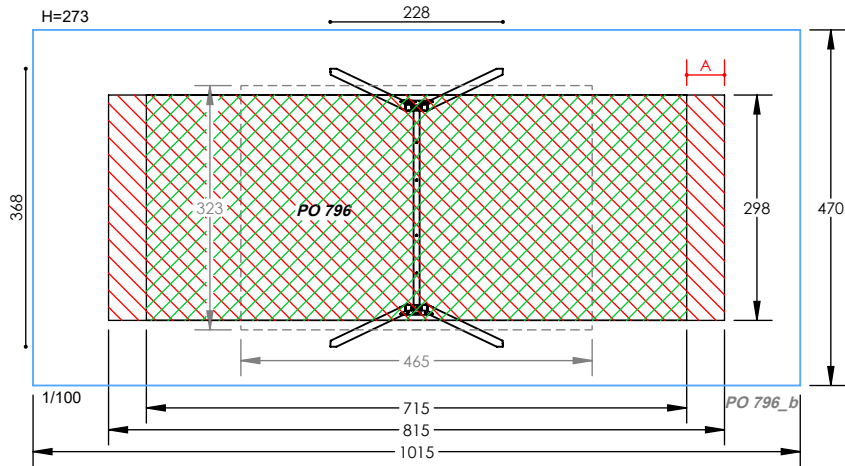

185



-  Sol meuble - Soft floor*150 : 25 m²
-  Sol synthétique - Synthetic floor*150 : 22 m²
-  Espace libre
Free space

A=50 Pour sol synthétique, Zone de sécurité sans obstacle
For synthetic floor, Safety area without obstacle

 Zone de sécurité minimale entre surface d'impact et clôture ou tout autres éléments de séparation
Minimal safety area between impact surface and fence or other separating elements



PO 796-03



03

PO 796-12



12

PO 796-15



15

PO 796-18



18

PO 796-22



22

PO 796-24



24

PO 796-14

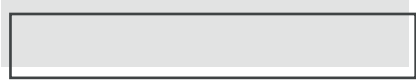

PO 796-16

