







-  x1
-  x1
-  x1
-  x1
-  x1
-  x1



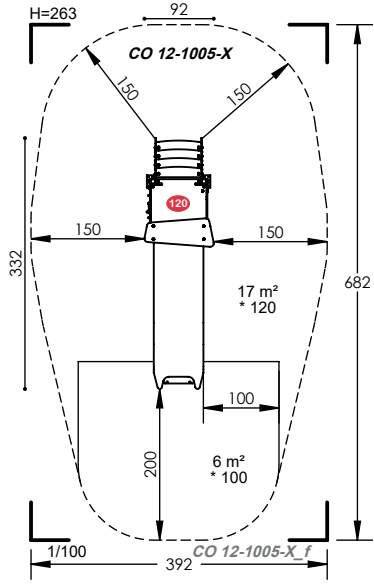
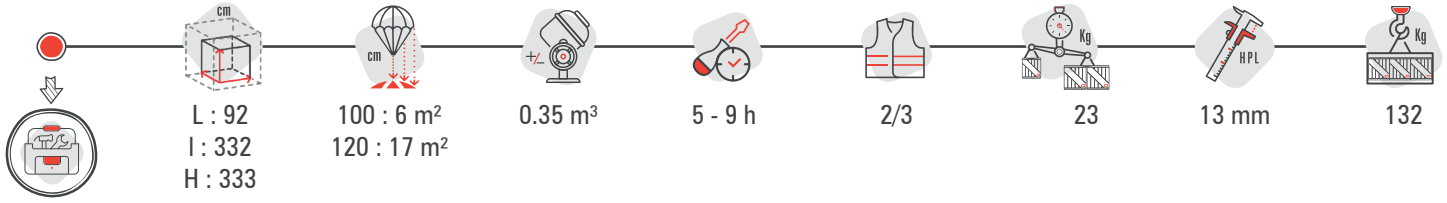

\*hauteur de chute libre - H : hauteur totale de l'équipement | \*free fall height - H: full height of the equipment